

Seesaw W1-07

Catalogue No.: W1-07



3-15



2



Dimensions	3,03 m x 0,42 m x 0,90 m
Safety zone	5,03 m x 2,42 m
Height of free fall	0,90 m
Number of users	2
Age	3-15 years
Material	<ul style="list-style-type: none">- glued laminated timber beams- steel components- HDPE or HPL- rubber buffers- galvanised carbon or stainless steel fasteners

Safety zone

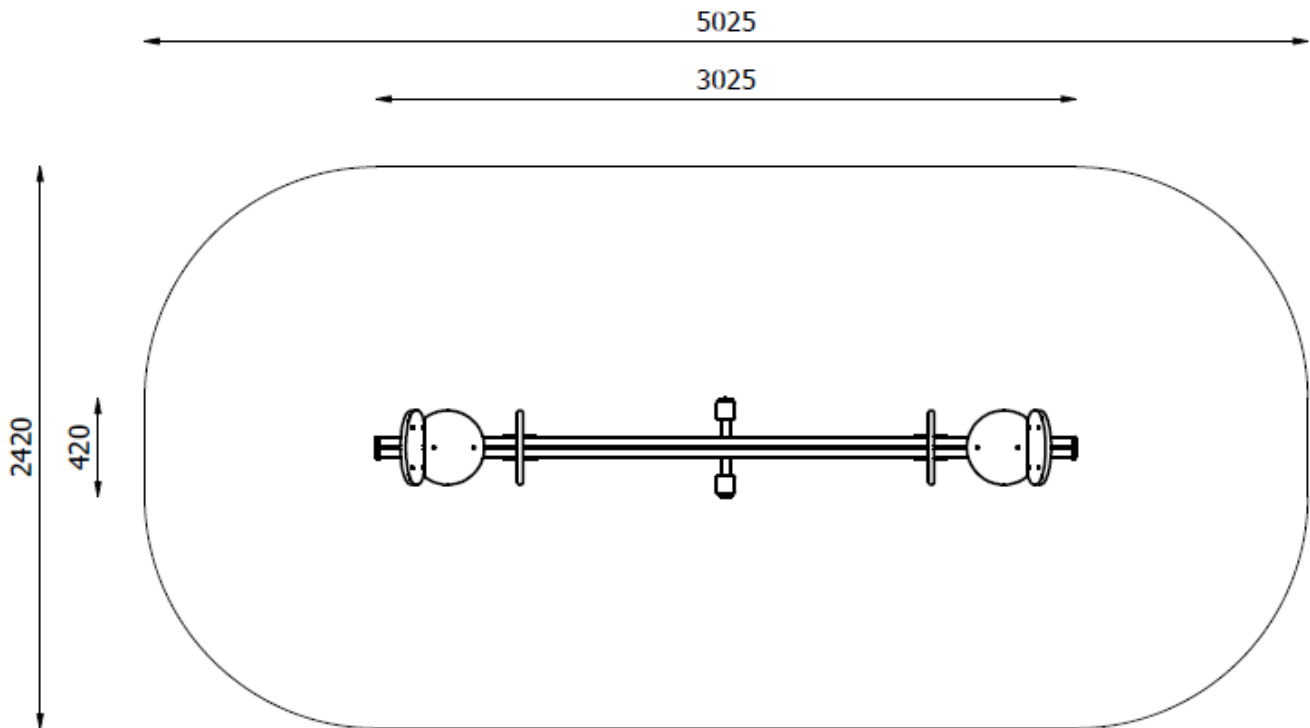

Description

The swing construction made of wood with dimensions 80x80, impregnated with the vacuum-pressure method. The remaining steel elements made of stainless steel or of carbon steel with corrosion protection by galvanizing and double powder coating. The seats made of HDPE or HPL panel. The bumpers mounted directly to the construction. Fasteners galvanized or of stainless steel.

Way of seating

The device construction mounted directly in the ground by sinking in concrete.

The manufacturer indicates that the real appearance of the above presented device may differ from visualization. All the construction or colouring changes are related to continuous process of device quality and aesthetics improvement.